

PRICE \$2.00

HEATHKIT®
ASSEMBLY MANUAL

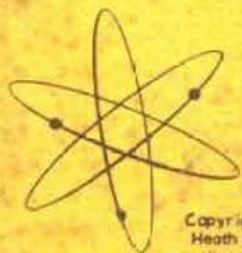

TRANSISTORIZED
DC POWER SUPPLY
MODEL HP-13A



Copyright © 1968
Heath Company
All rights reserved

595-1158-01
4-24-70

HEATH COMPANY • BENTON HARBOR, MICHIGAN

Assembly
and
Operation
of the



TRANSISTORIZED DC POWER SUPPLY

MODEL HP-13A

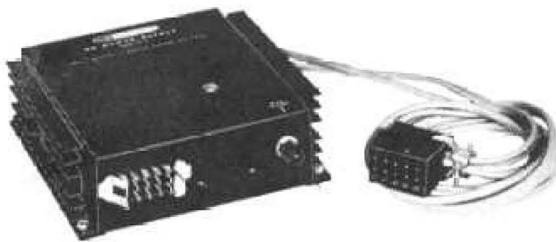

TABLE OF CONTENTS

Introduction,	2
Parts List,	3
Step-By-Step Assembly	
Parts Mounting,	4
Preliminary Wiring,	6
Circuit Board Wiring,	7
Heat Sink Assembly,	10
Chassis Wiring,	11
Final Wiring,	13
Mounting Cover,	14
Connector Wiring,	14
Installation,	16
In Case Of Difficulty,	18
Specifications,	19
Circuit Description,	20
Schematic, . . (fold-out from page),	20
Replacement Parts Price List,	23
X-Ray View,	24
Factory Repair Service,	24

HEATH COMPANY
BENTON HARBOR, MICHIGAN 49022

INTRODUCTION

The Heathkit Model HP-13A Transistorized DC Power Supply was designed to furnish all necessary operating power for Heathkit Mobile Amateur Transmitters, Transceivers, and Receivers, as well as for other brands of mobile equipment.

This Power Supply is actually three DC power sources in one unit. It provides high voltage (800 volts), low voltage (300 or 250 volts), and bias voltage (-40 to -130 volts). It also switches DC filament voltage for the equipment with which it is used.

Circuit features include relay control of all primary power, plus individual circuit breaker protection of the DC input to the Power Supply and of the DC filament voltage line to the equipment used with the Power Supply. The circuit breakers are the automatic reset, load delay type. They insure positive protection for all equipment involved in case of an overload or accidental short circuit.

The power transformer, an epoxy encapsulated toroid unit is of advanced design, assuring maximum efficiency. This transformer, in conjunction with the power transistors used as DC-to-AC converter, provides a high frequency switching rate along with high power and instant starting. Specially designed heat sink assemblies provide maximum transistor cooling.

Efficient, long life silicon rectifiers and heavy duty filter capacitors, mounted on a rugged circuit board, provide trouble-free rectification and filtering.

Because the complete Power Supply is physically small, it requires a minimum of mounting space. Under-the-hood mounting is recommended.

NOTE: Refer to the "Kit Builders Guide" for complete information on unpacking, parts identification, tools, wiring, soldering, and step-by-step assembly procedures.

PARTS LIST

To order replacement parts, refer to the Replacement Parts Price List and use the Parts Order Form furnished with this kit.

The numbers in parentheses in the Parts List are keyed to the numbers on the Parts Pictorial.

PART No.	PARTS Per Kit	DESCRIPTION	PART No.	PARTS Per Kit	DESCRIPTION
RESISTORS			HEAT SINKS		
(1)1-20	1	10 k Ω 1/2 watt (brown-black-orange)	(20)215-11-1	2	Heat sink (bottom section)
(2)1-15-2	1	1000 Ω 2 watt (brown-black-red)	(21)215-12-1	2	Heat sink (mid-section)
1-24-2	3	100 k Ω 2 watt (brown-black-yellow)	(22)215-13-1	4	Heat sink (top section)
(3)3-1-24	2	4 Ω 24 watt ceramic	HARDWARE		
(4)3-5-5	2	210 Ω 5 watt	(23)250-235	12	6-32 x 1/4" screw
CAPACITORS			(24)250-233	14	6-32 x 3/8" screw
(5)21-35	3	.005 μ fd 1.6 kV disc	(25)250-234	4	6-32 x 1/2" screw
(6)25-4	2	10 μ fd 25 V electrolytic	(26)250-364	2	6-32 x 7/8" screw
(7)25-206	1	20-20 μ fd 200 V electrolytic	(27)250-237	4	#6 x 3/8" sheet metal screw
25-207	5	20 μ fd 500 V electrolytic	(28)250-83	4	#10 x 1/2" sheet metal screw
25-28	1	100 μ fd 50 V electrolytic	(29)252-77	24	6-32 nut
(8)27-20	1	.4 μ fd Mylar* (polyester film)	(30)252-63	8	10-32 nut
CONTROL-CIRCUIT BREAKERS-RELAY			(31)252-76	1	Control nut
(9)11-81	1	15 k Ω control	(32)440-11	1	Plastic control guard
(10)65-20	1	10 ampere circuit breaker	(33)253-3	4	#10 fiber flat washer
65-14	1	30 ampere circuit breaker	(34)253-7	4	#10 fiber shoulder washer
69-10	1	12 volt relay	(35)253-96	2	#6 flat washer
CHOKES-TRANSFORMER-DIODE-TRANSISTORS			(36)253-10	1	Control flat washer
(11)45-59	1	Suppression choke	(37)254-1	25	#6 lockwasher
(12)46-24	1	Filter choke	(38)254-3	1	#10 lockwasher
(13)54-144	1	Power transformer	(39)255-23	4	Threaded spacer
(14)57-27	7	Silicon diode	(40)259-1	5	#6 solder lug
(15)417-120	2	Power transistor	(41)259-5	4	#10 solder lug
FUSEHOLDER-PLUG-CABLE CONNECTOR			(42)254-4	1	Control lockwasher
(16)423-6	1	In-line fuseholder and lead	(43)259-15	1	#8 solder lug (hook type)
(17)432-34	1	15-contact power plug	(44)259-20	2	Circuit board solder terminal
(18)432-35	1	15-contact cable connector	(45)259-21	2	5/16" solder lug
SHEET METAL PARTS			MISCELLANEOUS		
200-537	1	Chassis	85-78-2	1	Circuit board
(19)204-549	1	Circuit breaker mounting bracket	(46)260-32	2	Cable connector clip-lock
205-417-1	1	Bottom plate	344-2	1	Hookup wire
*DuPont Registered Trademark			346-2	1	Clear vinyl sleeving
			346-4	1	Black sleeving
			347-13	1	2-conductor cable
			347-18	1	8-conductor cable
			421-13	1	1/2 ampere fuse
			391-34	1	Blue and white identification label
			597-260	1	Parts Order Form
			597-308	1	Kit Builders Guide
				1	Manual (See front cover for part number.)
					Solder



RESISTANCE CHECKS

If an ohmmeter is available, it is advisable to make the following resistance checks to prevent possible damage to the Power Supply.

If the resistance values are not within $\pm 20\%$ of the values listed below, refer to the In Case Of Difficulty section on Page 18.

() Set the ohmmeter to the R x 1 scale.

Because some of the circuits to be measured contain diodes, you will obtain different resistance readings if the polarity of the meter leads is reversed in the following measurements. Therefore, in the first step you will determine the polarity of the ohmmeter test leads and connect the proper lead to chassis ground.

Refer to the X-Ray View on Page 24 for the next step.

() Connect the negative lead of the meter to the cathode lead (marked end) of diode D2. Connect the positive meter lead to the other lead of the diode. If the resistance is approximately 10 ohms, connect the negative meter lead to chassis ground for the following resistance checks. If the meter reads on or near infinity (full scale), reverse the meter leads on the diode. If you now get a reading of approximately 10 ohms, connect the positive meter lead to chassis ground.

Make resistance checks from chassis ground to the following points.

- () Terminal 1 of the power transformer - 50 Ω to 100 Ω . NOTE: This reading should be measured on the Rx1 scale.
- () Pin 15 of the power plug - 200 k Ω .
- () Pin 3 of the power plug - 100 k Ω .
- () Pin 9 of the power plug - 10 k Ω to 30 k Ω (reverse the meter leads for this check). NOTE: This reading varies with the setting of the Bias Adjust control.

MOUNTING COVER

() Place the cover on the Power Supply chassis. Use the four remaining #6 x

3/8" sheet metal screws and secure the cover to the chassis.

NOTE: The blue and white identification label shows the Model Number and Production Series Number of your kit. Refer to these numbers in any communications with the Heath Company; this assures you that you will receive the most complete and up-to-date information in return.

() Install the identification label in the following manner:

1. Select a location for the label where it can easily be seen when needed.
2. Carefully peel away the backing paper. Then press the label into position.

This completes the assembly of your HP-13A Power Supply.

CONNECTOR WIRING

Refer to Pictorial 7 (fold-out from Page 19) for the following steps.

Wire the 15-terminal cable connector as follows:

- () Remove 4" of insulation from one end of a length of hookup wire. Twist the strands together tightly and melt a small amount of solder on the very end of the bare wire.
- () Insert the bare end through lug 1, lug 4, lug 5, lug 2, and back through lug 1 of the connector. Solder all four lugs and the wire connected between them to form a soldered square. Cut off the excess wire.
- () Using the remaining length of bare wire in a like manner, insert the bare end through lug 13, lug 10, lug 11, lug 14, and back through lug 13 of the connector. Solder all four lugs and the wire connected between them to form a soldered square. Cut off the excess wire.
- () Referring to Detail 7A, remove 2" of the outer insulation from one end of the 8-wire cable. Then remove 1/4" of insulation from the ends of all of the exposed wires. Melt a small amount of solder on the wire ends.

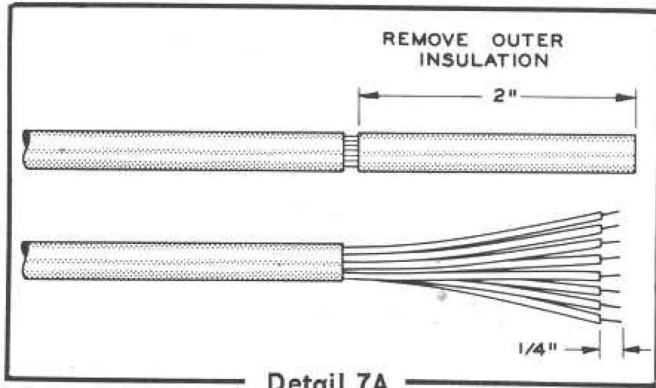

Detail 7A

Connect the prepared end of the 8-wire cable to the connector as follows:

- () Yellow to lug 15 (S-1).
- () Green to lug 9 (S-1).
- () Blue to lug 6 (S-1).
- () Orange to lug 3 (S-1).
- () Red to lug 8 (S-1).
- () Brown to lug 7 (S-1).
- () Connect the black and white wires around the wire connected between lugs 11 and 14 (S-2).
- () Referring to Detail 7B, remove 2" of the outer insulation from one end of the 2-wire cable. Then remove 1/2" of insulation from the ends of the red and brown wires.

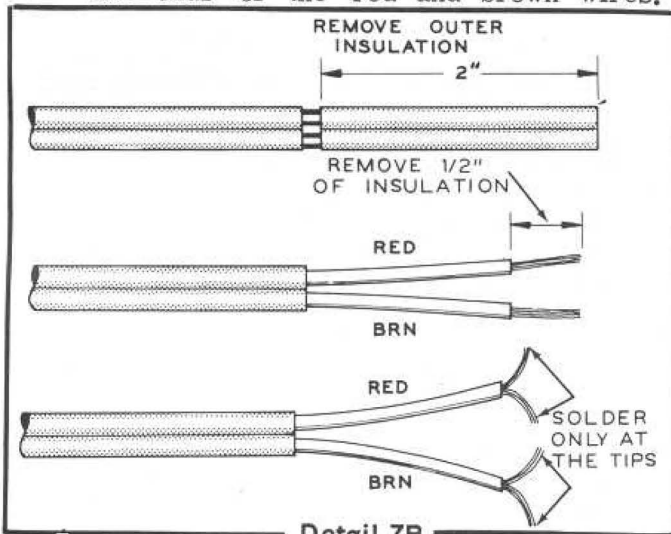

Detail 7B

- () Separate the strands of the red and brown wires as shown. Melt a small amount of solder on the very end of each separated end to hold the wire strands together.

- () Connect one of the separated ends of the red wire around the wire between lugs 1 and 4 of the connector (S-1).
- () Connect the other separated end of the red wire around the wire between lugs 2 and 5 of the connector (S-1). Cut off any excess wire.
- () Connect one of the separated ends of the brown wire around the wire between lugs 10 and 13 of the connector (S-1).
- () Connect the other separated end of the brown wire around the wire between lugs 11 and 14 of the connector (S-1). Cut off any excess wire.

Refer to Detail 7C for the following steps.

Assemble the connector, connector cover, and cable clamp as follows:

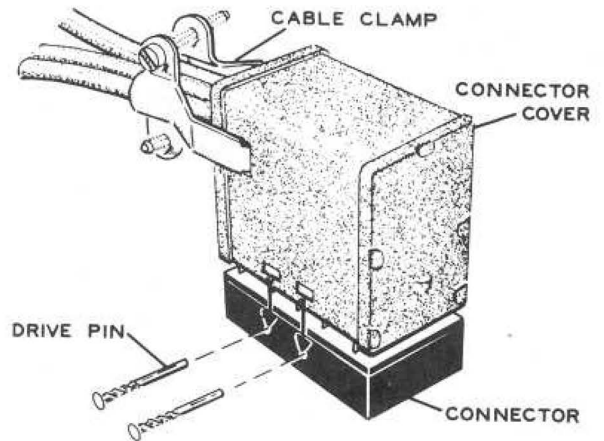

Detail 7C

- () Make sure the fiber insulation is inside the connector cover. Then insert the free ends of the 8-wire and 2-wire cables through the hole in the fiber insulation and connector cover.
- () Push the connector cover over the connector. Line up the holes of the cover with those in the connector. Then insert the two drive pins in the holes. Tap the pins lightly to avoid breaking the connector.
- () Make sure the cable clamp is installed in the slots in the connector cover and tighten the screws in the clamp.

NOTE: Refer to the instruction manual for your specific model of transmitter or transceiver for information on wiring the free end of the Power Supply cable. Pictorial 7 shows the connections provided by the color-coded wires of the Power Supply cable.

INSTALLATION

WARNING: Before installing this Power Supply in a vehicle, measure the generator or alternator output voltage. The voltage output of the charging system **MUST NOT EXCEED 16 VOLTS**. If necessary, have the vehicle voltage regulator adjusted for a maximum of 16 volts DC output.

MOUNTING CONSIDERATIONS

It is recommended that the Power Supply be mounted under the hood. Figure 3 shows several possible locations for under-the-hood mounting. Choose the mounting location that is best for your particular installation allowing ventilation and protection from water spray.

The Power Supply should be mounted as near to the vehicle battery or starter solenoid as practical. This will allow the 2-wire battery cable to be connected to either of these two points by the shortest route possible, consistent with proper cable installation.

The Power Supply should preferably be mounted with the heat sink fins vertical to provide maximum cooling of the transistor, however, this is not mandatory.

- () When the mounting position has been decided upon, use the Power Supply as a template and mark the four hole locations on the mounting surface. Drill a $9/64$ " hole at each of these four points.

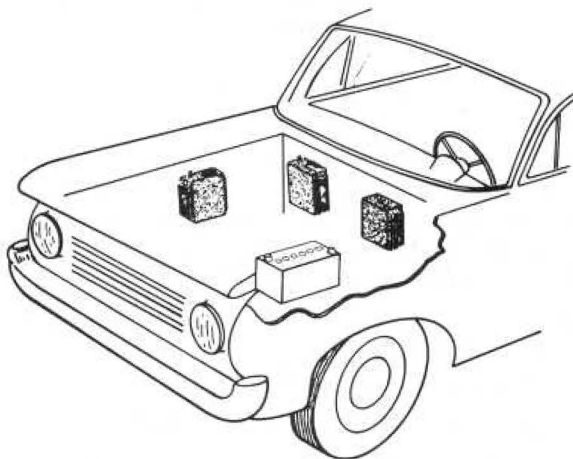

Figure 3

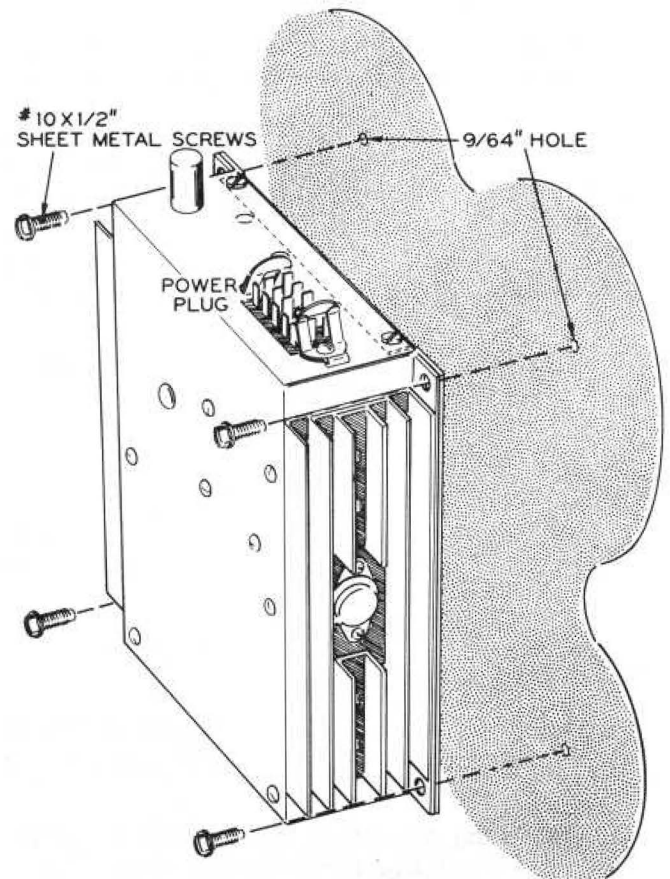

Figure 4

- () Referring to Figure 4, mount the complete unit at the prepared location. Start all four #10 x 1/2" sheet metal screws into the mounting surface, and then tighten securely.
- () Attach the power cable connector to the power plug, making sure the connector is pushed all the way onto the plug.

NOTE: Be very careful, when you install or remove the plastic control guard, that you do not change the setting of the Bias control.

- () Turn the Bias control fully clockwise, then install the plastic control guard. This position provides a fixed -130 VDC of bias. For equipment requiring a lower value than -130 volts, refer to the manual for that specific model and adjust the BIAS control accordingly.

BATTERY CONNECTIONS

NOTE: If the vehicle battery cables terminate in spring connectors, the 2-wire cable should be connect to the starter solenoid, instead of to the battery. Follow directions for the specific condition encountered,

CONNECTING TO BATTERY

- () Route the 2-wire cable to the battery. Make sure the cable clears all moving parts and is not near the exhaust manifold. Allow sufficient cable length so the wires can be connected to the battery terminals, then cut off the excess cable.
- () Slit the 2-wire cable, allowing enough brown and red wire length to easily reach the battery terminals. Remove the outer insulation and then remove 1/4" of insulation from the ends of the brown and red wires.
- () Attach and solder the 5/16" solder lugs to the wire ends,
- () Loosen and remove the nut of the negative (-) battery cable clamp. Then slip the terminal of the brown wire over the bolt and replace the nut, Tighten securely.
- () In a like manner, connect the red wire to the positive (+) battery terminal. Tighten the nut securely.

CONNECTING TO STARTER SOLENOID

- () Route the 2-wire cable to the starter solenoid. Make sure the cable clears all moving parts and is not near the exhaust manifold. Allow sufficient cable length so the brown wire will reach a good ground on the engine, and the red wire will reach the starter solenoid terminals. Cut off any excess cable.
- () Slit the 2-wire cable, allowing enough wire length to reach the connecting points. Remove the outer insulation and remove 1/4" of insulation from the ends of the wires.
- () Attach and solder the 5/16" solder lugs to the wire ends.

- () Connect the brown wire to a good ground (engine block or starter mounting bolts).
- () Connect the red wire to the battery terminal of the starter solenoid. This is the terminal to which the positive (+) battery cable is connected.

SWITCHING

The relay in the Power Supply can be energized by applying 12 volts DC to the relay coil from an external source. The relay controls all power to the equipment with which the Power Supply is used as well as to the Power Supply itself. In effect, the relay is an on-off switch for the entire system.

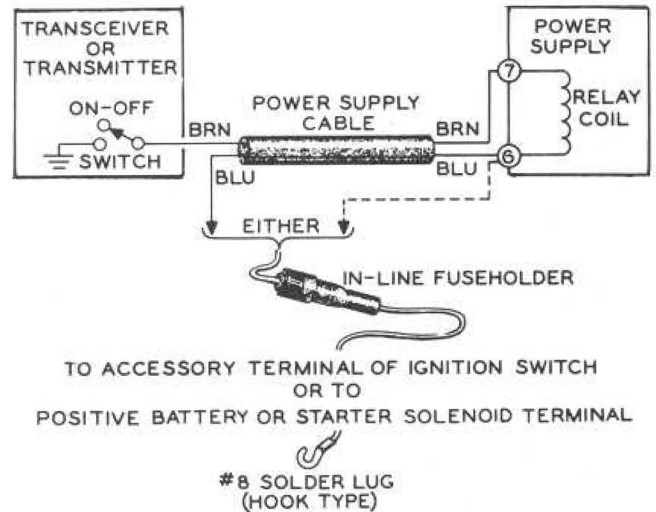

Figure 5

Some Heathkit Transceiver and Transmitter assembly manuals have specific information on making power switching connections to the Power Supply. If you do not have specific directions on this point, the following procedure should be used.

There are basically two ways to obtain 12 volts DC to control the relay: one way is directly from the ungrounded battery or starter solenoid terminal; the other, which is preferable, is from the ignition switch. Either source may be used. An in-line fuseholder and a hook type solder lug are supplied for this purpose. The hookup for switching is shown in Figure 5. One lead of the fuseholder should be connected to the 12 volt DC source; the other lead should be con-

nected to either pin 6 of the Power Supply cable connector, or to the blue wire at the free end of the Power Supply cable.

The relay can be energized by grounding the other side of the relay coil. This is usually accomplished by a simple SPST switch in the transceiver or transmitter with which the Power Supply is used. The brown wire at the free end of the Power Supply cable should be connected to one terminal of the switch, and the other terminal of the switch should be connected to ground. When the switch is closed, it completes

the 12 volt DC circuit for the relay coil, energizing the relay. The relay then turns on the complete system.

RELAY

If an overload or short circuit causes one or both of the circuit breakers to "open," the Power Supply must be turned off for approximately 30 seconds to permit the load delay thermal switch within the circuit breaker to reset and close the circuit again.

IN CASE OF DIFFICULTY

1. Recheck the wiring. Trace each lead in colored pencil on the Pictorial as it is checked. It is frequently helpful to have a friend check your work. Someone who is not familiar with the unit may notice something consistently overlooked by the constructor.
2. It is interesting to note that about 90% of the kits that are returned for repair, do not function properly due to poor connections and soldering. Therefore, many troubles can be eliminated by reheating all connections to make sure that they are soldered as described in the Kit Builders Guide.
3. Check the values of the parts. Be sure that the proper part has been wired into the circuit, as shown in the pictorial diagrams and as called out in the wiring instructions.
4. Check for bits of solder, wire ends or other foreign matter which may be lodged in the wiring.
5. If, after careful checks, the trouble is still not located and a voltmeter is available, check voltage readings against those shown on the Schematic Diagram. NOTE: All voltage reading were taken with an 11 megohm input voltmeter. Voltages may vary as much as 20%.
6. A review of the Circuit Description will prove helpful in indicating where to look for trouble. A logical method of troubleshooting will provide the best results. Check first to see that the Power Supply is connected properly to other equipment, and to the battery and relay switching sources. Recheck the wiring at each end of the Power Supply cable.

Since the relay is the on-off switch for the complete system, check its operation. Also check the circuit breakers. Repeated opening of a circuit breaker indicates an overload or short in the circuit supplied through the circuit breaker.

RESISTANCE CHECKS

1. Resistance from terminal 1 of the power transformer to chassis ground should be 50-100 Ω . NOTE: This should be measured with an ohmmeter on the RX1 scale. If the reading is below 30 ohms, either Q1 or Q2 or both are shorted. Reversed meter leads should give a reading of approximately 2 Ω .
2. Make forward and reverse resistance checks on diodes D1 through D7. This can be done by using an ohmmeter on the RX1 scale. In one direction the resistance will be 10 Ω ; reversing the leads should give a reading of infinity. If the readings vary greatly from the values given it would indicate that the diode is either open or shorted.
3. Check the circuit breakers for continuity.
4. Disconnect one lead of filter choke L1. The resistance of the choke is approximately .6 Ω .
5. Use the ohmmeter to check for continuity between the various transformer windings. NOTE: The transformer leads must be disconnected for this check.

NOTE: In an extreme case where you are unable to resolve a difficulty, refer to the Service and Warranty section of the "Kit Builders Guide", and to the "Factory Repair Service" information on Page 24 of this Manual.

SPECIFICATIONS

Input Voltage	12 to 16 volts DC (negative ground).
Input Current	25 amperes maximum with full load.
Allowable Ambient Temperature	-10 degrees Fahrenheit to 122 degrees Fahrenheit.
High Voltage Output	800 volts DC with no load, 750 volts DC with 250 mA load.
Effective Output Capacitance	10 μ fd.
Ripple	Less than 1% at 250 mA.
Duty Cycle	Continuous up to 150 mA, 50% up to 300 mA, SSB duty up to 300 mA.
Low Voltage Output (High Tap)	310 volts DC with no load, 300 volts DC with 150 mA load.
Ripple	Less than .05% at 150 mA.
Duty Cycle	Continuous up to 175 mA.
Low Voltage Output (Low Tap)	265 volts DC with no load, 250 volts DC with 150 mA load.
Ripple	Less than .05% at 150 mA.
Duty Cycle	Continuous up to 175 mA.
Adjustable Bias Voltage	-40 to -130 volts DC.
Duty Cycle	20 mA at -130 volts to 1 mA at -40 volts continuous.
Switching Frequency	1500 Hz (approximate).
Cabinet Dimensions	7-3/4" wide x 7-5/16" long x 2-3/8" deep.
Net Weight	5-1/4 lbs.

NOTE: A 13.0 volt DC input was used in determining electrical specifications.

The Heath Company reserves the right to discontinue instruments and to change specifications at any time without incurring any obligation to incorporate new features in instruments previously sold.

CIRCUIT DESCRIPTION

While reading the following Circuit Description, refer to the Power Supply Schematic and Block Diagrams and to the Figures in the text to obtain a thorough understanding of circuit operation.

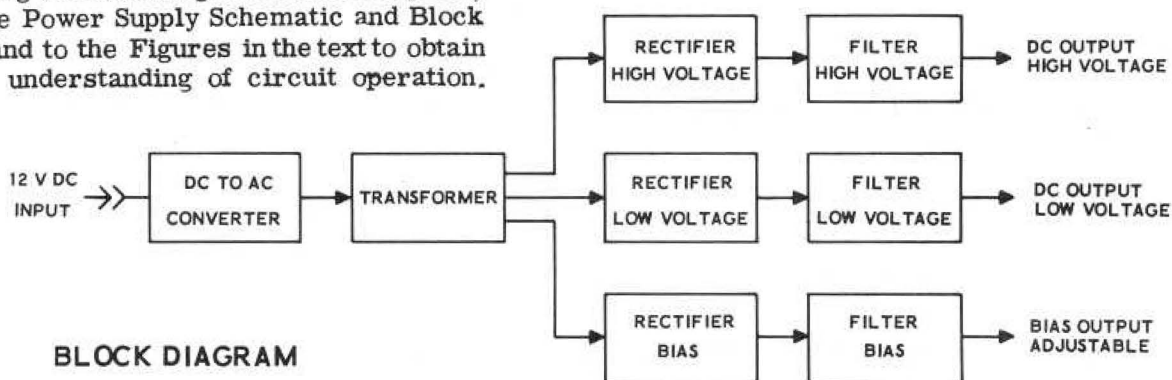

BLOCK DIAGRAM

PRIMARY CIRCUIT

The battery voltage available at the 15-terminal input-output connector of the Power Supply is applied through a 30 ampere circuit breaker to the relay contacts. When the relay is energized by external switching of 12 volts DC to the relay coil, this DC voltage is connected through the relay and through a 10 ampere circuit breaker to the filament voltage terminal of the connector. Battery voltage is also applied through suppression choke L2 to the center of the transformer primary winding.

To produce the high DC voltages required to operate mobile electronic equipment, a suitable converter must be used to change battery voltage (DC) to alternating current (AC) for the necessary transformer voltage step-up action. In the Transistorized Power Supply, this conversion is accomplished with two heavy duty transistors which act as switches, and a very efficient toroid power transformer.

The switching action of the transistors is similar to that of a vibrator which uses a contact-carrying, vibrating reed to energize first one half and then the other half of the transformer primary winding. However, a vibrator is an electromechanical switch whose contacts may, after use, become burned and pitted, requiring replacement of the vibrator.

The two transistors also alternately connect battery voltage across first one half then the other half of the transformer primary winding. As there are no moving parts involved in this system, mechanical wear is eliminated. Tran-

sistors have extremely long life characteristics and require a minimum of maintenance. Transistor switching action is shown in Figures 1A, B, and C.

The basic converter circuit is shown in Figure 2, which indicates the relative phase and amplitude of the primary and secondary voltages. When power is first applied to the primary circuit, an imbalance will exist between the two transistor circuits due primarily to slight differences in transistor and transformer winding characteristics. This imbalance causes one transistor to momentarily take control and apply battery voltage across one section of the transformer primary winding, either section A1 or A2 depending upon which transistor is in initial control.

The polarity of the base feedback voltage, with respect to the transformer primary, is such that it drives the "initial control" transistor into very heavy conduction; collector current is several amperes, depending upon the load on the Power Supply output. Degeneration causes the other transistor to be cut off completely.

This condition of high current flow will continue until the transformer core reaches saturation. When core saturation occurs, the rate of change of flux approaches zero. The circuit is then unable to maintain the large driving current in the base circuit of the conducting transistor, resulting in a decrease of collector current. This decrease in collector current causes a further decrease of base drive. Circuit feedback is such that continued reduction of base drive

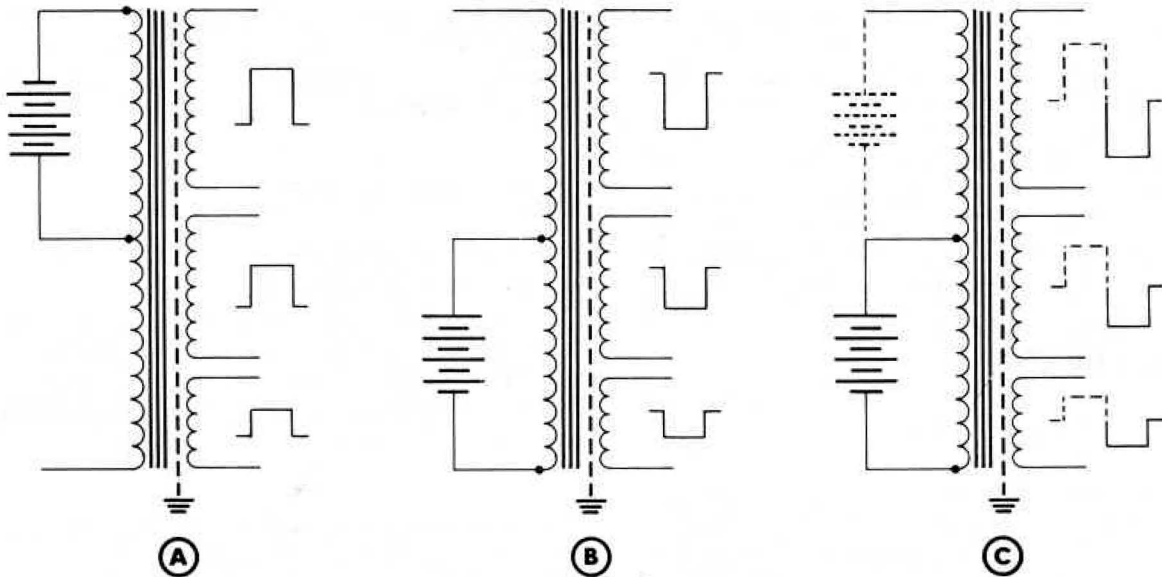

Figure 1

causes the conducting transistor to stop conducting (switch off), and the other transistor to begin conducting (switch on).

As the primary circuitry is symmetrical, the operation of the second transistor is identical to that of the initial control transistor. The conditions are duplicated, causing resaturation of the transformer core. This rapid change in core saturation induces a square wave alternating voltage in the transformer secondary windings, in proportion to the turns ratio between the primary and secondary. The cycle will continue to repeat itself and produce the necessary high voltage AC in the transformer secondary windings.

The transformer used in this Power Supply is a very efficient toroid type, designed to operate at a frequency of approximately 1500 Hz. The transformer will run relatively warm even under no load. This condition is normal for a transformer operated near or in a saturated condition.

The transistors operate at a nominal switching frequency of 1500 Hz. This frequency represents a good compromise of efficiency, filtering, and operating temperatures. At higher frequencies, the time required for the transistors to switch on and off is a large portion of the operating cycle; this results in low efficiency. At lower frequencies, larger value filter capacitors would be required and a much larger transformer would be needed. The switching frequency is determined by a number of factors, including transistor circuit values, and transformer and transistor characteristics.

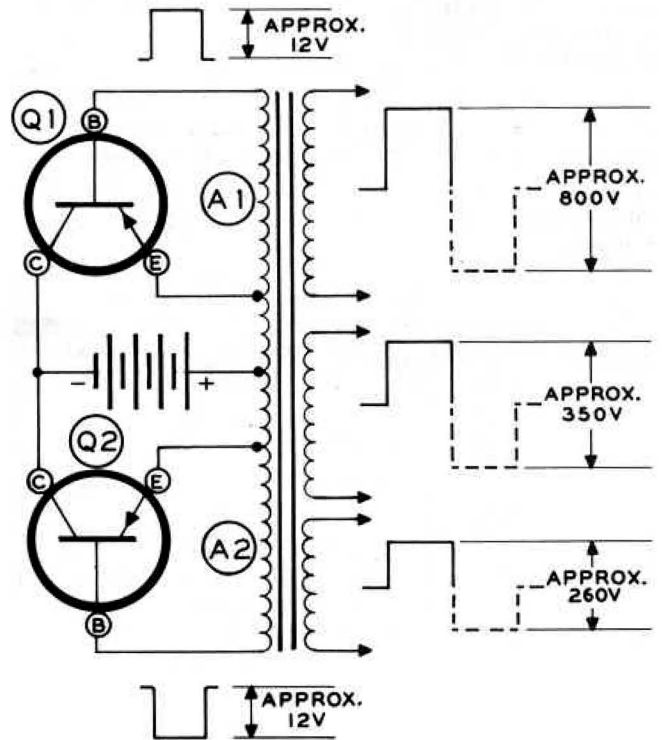

Figure 2

Transistors must operate at relatively low temperatures, as high temperature operation will greatly increase leakage currents and sharply reduce efficiency and reliability. Transistors used in this type of switching application operate at high current during one-half of each cycle. The transistor heat which occurs is effectively dissipated by radiation from the heat sink assemblies, which are cooled by air circulating around the heat sink fins.

SECONDARY CIRCUIT

HIGH VOLTAGE SECTION

The high voltage DC section uses a full-wave voltage-doubler circuit, consisting of diodes D1, D2, D3, and D4 with capacitors C3 and C4. A voltage-doubler circuit produces a DC output of approximately twice the peak value of the alternating voltage available at the secondary winding of the transformer. Diodes D1 and D2 rectify one-half cycle of voltage, and D3 and D4 rectify the other half cycle. On alternate half cycles, capacitors C3 and C4 charge to the approximate value of the AC voltage appearing across the transformer secondary winding. The polarity is such that the DC voltages developed across these two capacitors add together; this "doubled" DC voltage appears between ground and the junction of D4, C3, and R3. Capacitors C3 and C4 with resistors R3 and R4 provide filtering. R3 and R4 also act as bleeder resistors to provide a discharge path for the voltage doubler capacitors when the power supply is turned off.

Buffer capacitor C2 absorbs transient voltage surges that occur in the secondary winding as a result of transistor switching action in the primary circuit.

LOW VOLTAGE SECTION

The low voltage DC section also uses a full-wave voltage-doubler circuit, made up of diodes D5 and D6 with capacitors C8 and C10. Capacitors C8, C9, and C10 with choke L1 filter the DC output voltage, which is then applied to the Power Supply connector. R5 is a bleeder resistor, and C7 is a buffer capacitor.

The low voltage secondary winding is tapped to provide a choice of two different output voltages. Either the blue-green or the blue-yellow transformer lead may be connected to the voltage-doubler circuit. The blue-green lead provides the higher output voltage. The choice of output voltages depends on the requirements of the equipment with which the Power Supply is used.

BIAS SECTION

The bias voltage section uses diode D7 as a half-wave rectifier. The filter network consists of capacitors C11A and C11B with resistor R8. Control R10 facilitates adjustment of the bias voltage output from approximately one-third to the full available voltage. Resistor R9 with control R10 also form a bleeder circuit.

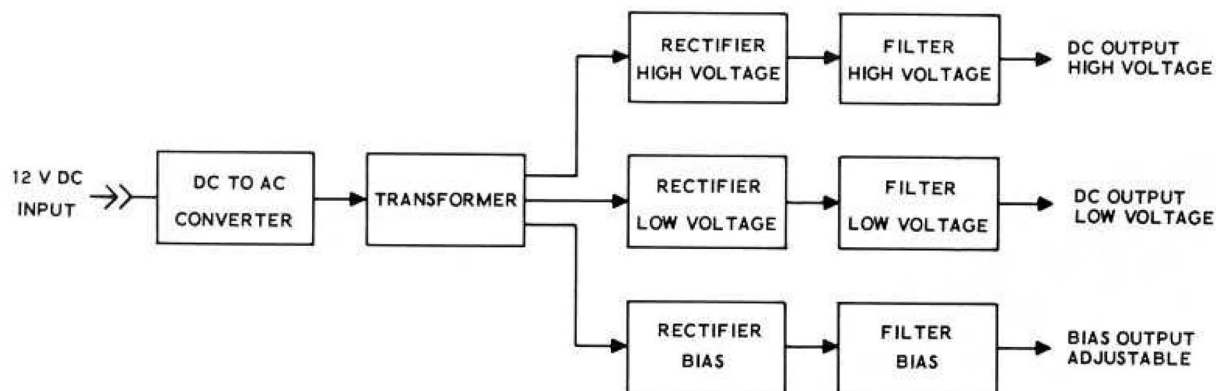

BLOCK DIAGRAM

(Repeat)

REPLACEMENT PARTS PRICE LIST

To order parts, use the Parts Order Form furnished with this kit. If Parts Order Form is

not available, refer to Replacement Parts in the Kit Builders Guide.

PART No.	PRICE Each	DESCRIPTION
RESISTORS		
1-20	.10	10 k Ω 1/2 watt
1-15-2	.20	1000 Ω 2 watt
1-24-2	.20	100 k Ω 2 watt
3-1-24	.85	4 Ω 24 watt ceramic
3-5-5	.25	210 Ω 5 watt

PART No.	PRICE Each	DESCRIPTION
CAPACITORS		
21-35	.15	.005 μ fd 1.6 kV disc
25-4	.50	10 μ fd 25 V electrolytic
25-206	.85	20-20 μ fd 200 V electrolytic
25-207	.85	20 μ fd 500 V electrolytic
25-28	.70	100 μ fd 50 V electrolytic
27-20	.35	.4 μ fd Mylar (polyester film)

PART No.	PRICE Each	DESCRIPTION
CONTROL-CIRCUIT BREAKERS-RELAY		
11-81	2.35	15 k Ω control
65-20	.80	10 ampere circuit breaker
65-14	.80	30 ampere circuit breaker
69-10	4.90	12 volt relay

PART No.	PRICE Each	DESCRIPTION
CHOKES-TRANSFORMER-DIODE-TRANSISTORS		
45-59	.60	Suppression choke
46-24	1.00	Filter choke
54-144	27.60	Power transformer
57-27	.60	Silicon diode
417-120	5.00	Power transistor

PART No.	PRICE Each	DESCRIPTION
FUSEHOLDER-PLUG-CABLE CONNECTOR		
423-6	1.40	In-line fuseholder and lead
432-34	1.20	15-contact power plug
432-35	1.90	15-contact cable connector

PART No.	PRICE Each	DESCRIPTION
SHEET METAL PARTS		
200-537	1.55	Chassis
204-549	.15	Circuit breaker mounting bracket
205-417-1	.85	Bottom plate

PART No.	PRICE Each	DESCRIPTION
HEAT SINKS		
215-11-1	.60	Heat sink (bottom section)
215-12-1	.25	Heat sink (mid-section)
215-13-1	.15	Heat sink (top section)

PART No.	PRICE Each	DESCRIPTION
HARDWARE		
250-235	.05	6-32 x 1/4" screw
250-233	.05	6-32 x 3/8" screw
250-234	.05	6-32 x 1/2" screw
250-364	.05	6-32 x 7/8" screw
250-237	.05	#6 x 3/8" sheet metal screw
250-83	.05	#10 x 1/2" sheet metal screw
252-77	.05	6-32 nut
252-63	.05	10-32 nut
252-76	.10	Control nut
440-11	.10	Plastic control guard
253-3	.05	#10 fiber flat washer
253-7	.10	#10 fiber shoulder washer
253-96	.05	#6 flat washer
253-10	.05	Control flat washer
254-1	.05	#6 lockwasher
254-3	.05	#10 lockwasher
255-23	.10	Threaded spacer
259-1	.05	#6 solder lug
259-5	.05	#10 solder lug
254-4	.05	Control lockwasher
259-15	.05	#8 solder lug (hook type)
259-20	.05	Circuit board solder terminal
259-21	.05	5/16" solder lug

PART No.	PRICE Each	DESCRIPTION
MISCELLANEOUS		
85-78-2	1.80	Circuit board
260-32	.45	Cable connector clip-lock
344-2	.05/ft	Hookup wire
346-2	.05	Clear vinyl sleeving
346-4	.05/ft	Black sleeving
347-13	.20/ft	2-conductor cable
347-18	.15/ft	8-conductor cable
421-13	.15	1/2 ampere fuse
331-6	.15	Solder
	2.00	Manual (See front cover for part number.)

The above prices apply only on purchases from the Heath Company where shipment is to a U.S.A. destination. Add 10% (minimum 25 cents) to the price when ordering from an authorized Service Center or Heathkit Electronic Center to cover local sales tax, postage and handling. Outside the U.S.A. parts and service are available from your local Heathkit source and will reflect additional transportation, taxes, duties and rates of exchange.

X-RAY VIEW

(VIEWED FROM LETTERED SIDE)

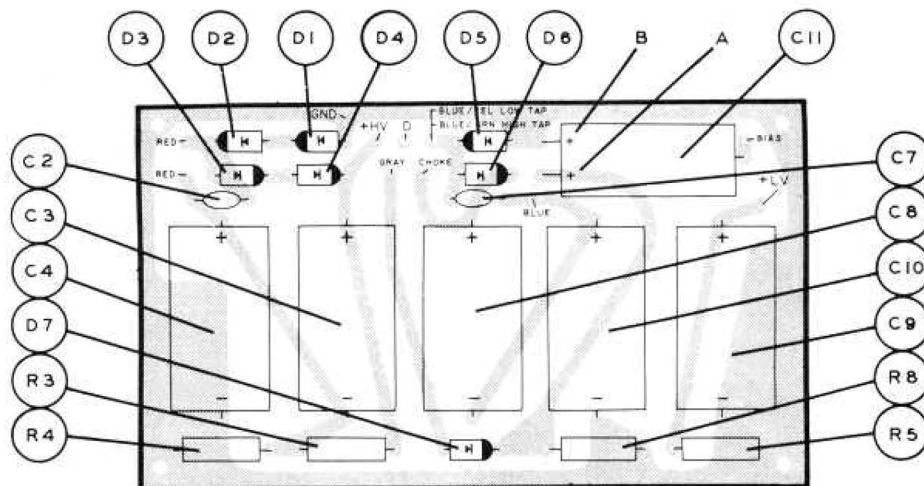

FACTORY REPAIR SERVICE

You can return your completed kit to the Heath Company Service Department to have it repaired for a minimum service fee. (Kits that have been modified will not be accepted for repair.) If you wish, you can deliver your kit to a nearby Heath Authorized Service Center. These centers are listed in your Heathkit catalog.

To be eligible for replacement parts under the terms of the warranty, equipment returned for factory repair service, or delivered to a Heath Authorized Service Center, must be accompanied by the invoice or the sales slip, or a copy of either. If you send the original invoice or sales slip, it will be returned to you.

If it is not convenient to deliver your kit to a Heath Authorized Service Center, please ship it to the factory at Benton Harbor, Michigan and follow the following shipping instructions:

Prepare a letter in duplicate, containing the following information:

- Your name and return address.
- Date of purchase.
- A brief description of the difficulty.
- The invoice or sales slip, or a copy of either.

- Your authorization to ship the repaired unit back to you C.O.D. for the service and shipping charges, plus the cost of parts not covered by the warranty.

Attach the envelope containing one copy of this letter directly to the unit before packaging, so that we do not overlook this important information. Send the second copy of the letter by separate mail to Heath Company, Attention: Service Department, Benton Harbor, Michigan.

Check the equipment to see that all parts and screws are in place. (Do not include wooden cabinets when shipping receivers, tuners, amplifiers, or TV sets, as these are easily damaged in shipment.) Then, wrap the equipment in heavy paper. Place the equipment in a strong carton, and put at least **THREE INCHES** of resilient packing material (shredded paper, excelsior, etc.) on all sides, between the equipment and the carton. Seal the carton with gummed paper tape, and tie it with a strong cord. Ship it by prepaid express, United Parcel Service, or insured parcel post to:

Heath Company
Service Department
Benton Harbor, Michigan 49022

- NOTES:
 ALL RESISTANCES IN OHMS (K = 1000, M = 1,000,000).
 ALL VOLTAGES MEASURED FROM INDICATED POINT TO CHASSIS GROUND.
 POWER PLUG TERMINALS VIEWED FROM INSIDE OF CHASSIS.
 C AND R LETTER-NUMBER DESIGNATIONS SHOWN ON CIRCUIT BOARD X-RAY VIEW
- (*) ORDER BY PART NUMBER FROM HEATH COMPANY.
 (**) +250 V DC LOW TAP,
 +300 V DC HIGH TAP.
 (***) LUG #6 AND/OR LUG #7 MAY HAVE 12 V DC WITH RESPECT TO GROUND, DEPENDING UPON THE SPECIFIC CIRCUITRY AND CONNECTIONS OF THE EQUIPMENT USED WITH THE POWER SUPPLY.

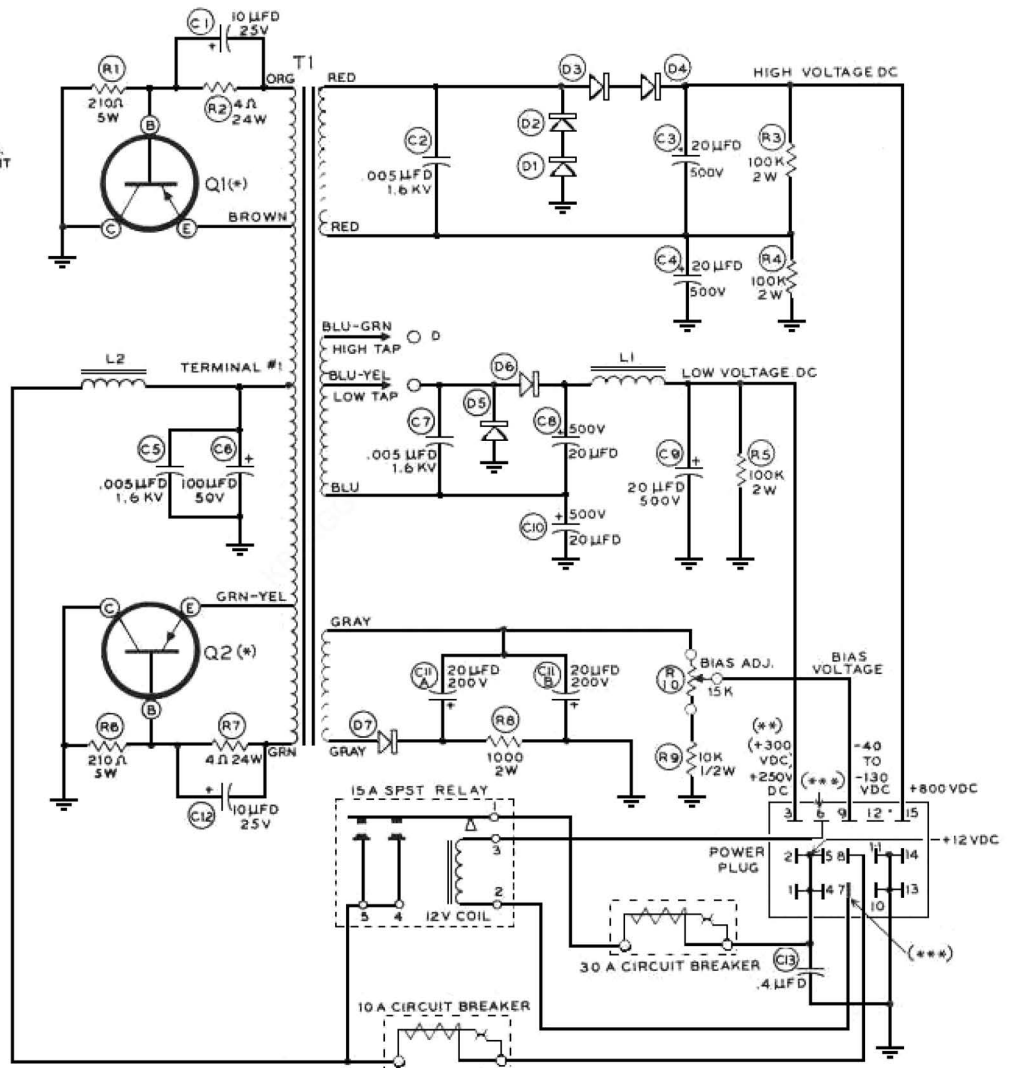



















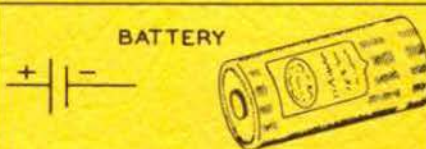
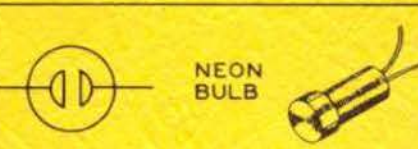
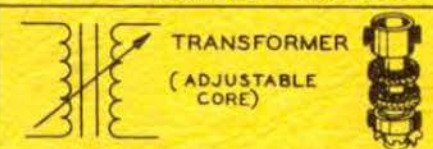

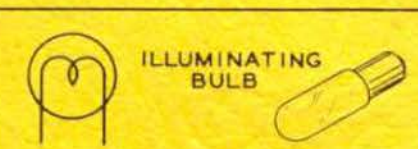
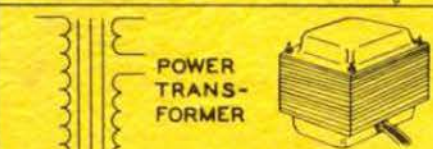

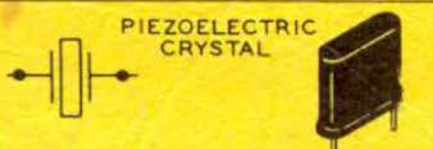

**SCHEMATIC OF THE
 HEATHKIT®
 TRANSISTORIZED
 DC POWER SUPPLY
 MODEL HP-13A**

TYPICAL COMPONENT TYPES

This chart is a guide to commonly used types of electronic components. The symbols and related illustrations

should prove helpful in identifying most parts and reading the schematic diagrams.

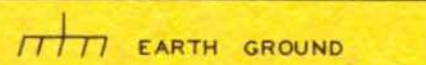
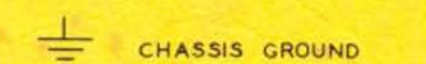
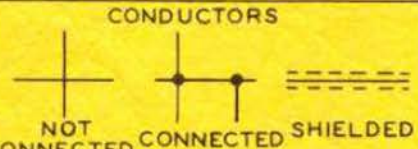
<p style="text-align: center;">RESISTOR</p> 	<p style="text-align: center;">CAPACITOR</p> 	<p style="text-align: center;">TUBE</p> 
<p style="text-align: center;">POTENTIOMETER (CONTROL)</p> 	<p style="text-align: center;">ELECTROLYTIC CAPACITOR</p> 	<p style="text-align: center;">TRANSISTOR</p> 
<p style="text-align: center;">TRANSFORMER (IRON CORE)</p> 	<p style="text-align: center;">VARIABLE CAPACITOR</p> 	<p style="text-align: center;">RECTIFIER (DIODE)</p> 
<p style="text-align: center;">TRANSFORMER (ADJUSTABLE POWDERED IRON CORE) ARROW INDICATES DIRECTION OF CORE MOVEMENT TO INCREASE INDUCTANCE</p> 	<p style="text-align: center;">BATTERY</p> 	<p style="text-align: center;">NEON BULB</p> 
<p style="text-align: center;">TRANSFORMER (ADJUSTABLE CORE)</p> 	<p style="text-align: center;">PHONO JACK</p> 	<p style="text-align: center;">ILLUMINATING BULB</p> 
<p style="text-align: center;">POWER TRANSFORMER</p> 	<p style="text-align: center;">PHONE JACK</p> 	<p style="text-align: center;">METER</p> 
<p style="text-align: center;">INDUCTOR (COIL)</p> 	<p style="text-align: center;">RECEPTACLE</p> 	<p style="text-align: center;">SWITCH (TOGGLE)</p> 
<p style="text-align: center;">PIEZOELECTRIC CRYSTAL</p> 	<p style="text-align: center;">SPEAKER</p> 	<p style="text-align: center;">SWITCH (ROTARY)</p> 
<p style="text-align: center;">BINDING POST</p> 	<p style="text-align: center;">MICROPHONE</p> 	<p style="text-align: center;">FUSE</p> 
<p style="text-align: center;">ANTENNA</p>  <p style="text-align: center;">GENERAL LOOP</p>	<p style="text-align: center;">EARTH GROUND</p>  <p style="text-align: center;">CHASSIS GROUND</p> 	<p style="text-align: center;">CONDUCTORS</p>  <p style="text-align: center;">NOT CONNECTED CONNECTED SHIELDED</p>

HEATH COMPANY

BENTON HARBOR, MICHIGAN

THE WORLD'S FINEST ELECTRONIC EQUIPMENT IN KIT FORM

LITHO IN U. S. A.