

SHERWOOD

MODEL S-3000

FM TUNER

OPERATION, INSTALLATION, and SERVICE MANUAL

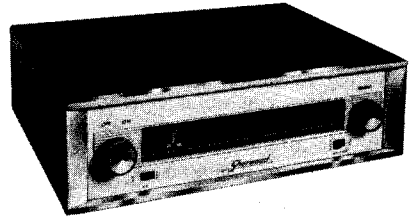

SHERWOOD MODEL S-3000 FM TUNER

SPECIFICATIONS

CIRCUITS: FM—Low noise balanced antenna input transformer feeding cascode RF amplifier. Triode mixer, 2 IF amplifiers, cascaded limiters, and Foster-Seeley

balanced discriminator. Delayed AGC applied to RF stage. AFC on oscillator. Feather-ray tuning eye.

AUDIO—cathode follower with level control.

TYPICAL SENSITIVITY:
0.95 μ v for 20 db. quieting
1.8 μ v for 30 db. quieting
3.6 μ v for 50 db. S/N

FREQUENCY RESPONSE:
20-20,000 cps $\pm \frac{1}{2}$ db.

AFC CORRECTION: 16 db.

OUTPUT: 2.0 Volts @ 100% FM
OSCILLATOR RADIATION: 6 db.
below FCC requirements

TYPICAL SELECTIVITY:
200 kc @ -6db

DISTORTION:
Less than 1/3% IM @ 100% mod.
(60/kc: 4/1 w/std. preemphasis),
Less than 1% harmonic @ 100%
mod., 400 cps.

ANTENNA: 300 ohm balanced
OUTPUTS: cathode-follower audio,
FM multiplex

FM DISCRIMINATOR: 600 kc. peak-to-peak

HUM AND NOISE LEVEL:
60 db. below 100% mod.

POWER CONSUMPTION:
40 watts, 110-120v, 50-60 cps.

TUNING RANGE:
87.5-108.5 mc

FM DRIFT:
 ± 2 kc w/AFC
 ± 15 kc w/o AFC

DIMENSIONS: 14x10 $\frac{1}{2}$ x4 in. high
SHIPPING WEIGHT: 16 lbs.

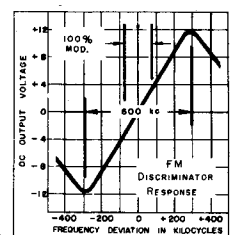
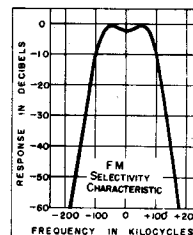
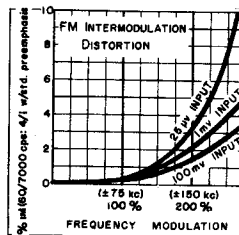
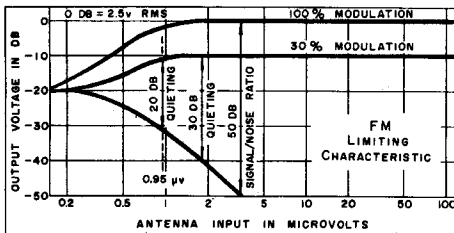

To obtain the utmost satisfaction with your new Sherwood S3000 FM tuner, review carefully the operation and installation sections of this booklet. The S-3000 has been styled and designed primarily as an operating mate for the Sherwood Model S-1000 amplifier, however it has operating flexibility which will work effectively with practically any good high-fidelity amplifier system.

The Model S-3000 tuner can be used either in its self-contained metal cabinet (for open-shelf or table-top mounting) or the cabinet can be removed and the tuner built into your custom cabinetry. Refer to sec-

tion under "Custom-Panel Installation" for further details.

UNPACKING—After unpacking your tuner, examine it carefully for indications of damage caused by shipping. If, for example, the cabinet has been dented or tubes broken, file a claim immediately with your carrier or dealer.

Enclosed with this manual are four mounting screws, an audio interconnecting cable, and your warranty card. The warranty card explains Sherwood's one-year warranty against defects. It should be mailed immediately to fulfill warranty requirements.

SHERWOOD ELECTRONIC LABORATORIES, INC., CHICAGO 18, ILLINOIS

INSTALLATION

The S-3000 tuner usually is located to provide the greatest operating convenience--on a chairside table, desk, bookshelf, or in a conventional radio cabinet. It is recommended that tuner installations in the fringe area of radio stations use external antennas. In this case, the tuner should be located where it is accessible to the antenna lead-in. Metropolitan or suburban installations can satisfactorily use the built-in antennas without need for antenna lead-in considerations. Up to 75 feet of shielded cable may separate the tuner and amplifier for remote installations.

IMPORTANT—Allow at least 2 inches behind the rear of your tuner for adequate ventilation and cabling convenience. Never place the unit near radiators or in front of heating vents. Excessive heat tends to shorten the life of the parts.

PANEL MOUNTING—The S-3000 tuner is a self contained, self-cabineted unit which is easily adapted for panel mounting in custom cabinetry. The enclosed full-size mounting template should be used for custom installation.

To mount the Sherwood tuner behind a panel, first remove the two front control knobs with a steady outward pull. Now unscrew the 4 machine screws holding the metal cover. Remove cover and panel assembly by sliding forward from chassis.

Disassemble the bezel from cover by unscrewing its 4 retaining screws. Remove the two "L" side brackets from the front corners of the chassis. Fasten these side brackets to the bezel (keeping front panel behind bezel) using the screws that formerly held the bezel to the cover. Slide bezel assembly over knobs and attach brackets to chassis so that the panel is snug against dial. Replace knobs.

Cut panel cutout 3-5/8 x 13-3/4 as shown on template. Slide tuner through cutout from the front. The chassis should be provided with either a shelf or rails to support its weight. Holes may be drilled as shown in the supporting members to fasten chassis securely with the mounting screws that are supplied.

ELECTRICAL CONNECTIONS

AUDIO OUTPUT - A shielded interconnecting cable with phono plugs has been included as an accessory with your tuner. This cable may be used to connect the tuner with your amplifier. Insert one end firmly into the jack labeled "audio output" (at the rear of the tuner.) The other end should be plugged into a high-level input such as those marked "A", "B", or "C" on the Model S-1000 amplifier. Interconnections may be made up to 75 feet by using a similar-type shielded cable.

FM ANTENNA - Connected to the FM antenna terminals are two lengths of plastic covered wire. Unwrap these wires and extend them in opposite directions and perpendicular to the direction of your station location. For urban locations having good signal strength, the antenna lead can be concealed by Scotch taping to the line cord. To reduce noise, fading, or interference on weak, distant stations, use a roof-top 300-ohm FM antenna array and 300-ohm ribbon lead-in. A somewhat less-effective antenna system can be built in the

attic from 5 feet of 300-ohm TV lead-in. Split one side of this lead and connect another piece of 300-ohm lead-in to serve as its lead in. Twist the two ends together as shown in Fig. 1 and solder. Tack antenna perpendicular to the direction of your station location. Best performance will be indicated by the widest pattern on the tuning eye.

Direct interconnection with a TV antenna lead is also permissible. If interference from this interconnection is suspected, a connection with less coupling may be made by taping about 5 inches of the FM tuner 300-ohm lead adjacent to the TV lead without actually making a direct connection.

Although the FM antenna input is designed for 300-ohm balanced input, a 70-ohm unbalanced cable may be connected to one of the FM terminals and ground.

MULTIPLEX OUTPUT—This jack provides a non-emphasized signal from the FM section at high impedance for connection to a multiplex converter. (Multiplex FM transmission, still in the developmental stage, will provide 2 or 3 programs on one station.)

POWER CONNECTION—Plug the S-3000 line cord into a wall outlet or amplifier power outlet supplying 110-120V, 50-60 cycle AC only. Special models for 220-240 V are clearly marked on the nameplate.

OPERATION

To operate, turn the left-hand knob clockwise; the dial will then be lighted. Tune station for clearest signal with tuning knob; the tuning eye will open widest at the point of best tuning.

FM AFC SWITCH - Normal usage is with AFC "on" and allows the electronic automatic frequency control to aid in tuning to the center or least-distorted point of each FM station. In addition, AFC reduces any tendency for the tuner to drift or detune away from a station. Where a weak station is being tuned on a channel adjacent to a much stronger station, the AFC may be turned to "off" to prevent the stronger station from pulling the tuning away from the desired weaker station.

LOCAL-DISTANT SWITCH - Normal operation is with this switch in the "Distant" position. Where the tuner is used near a powerful transmitter, the nearby station might be noted to have several points throughout the band where it can be heard. To suppress this effect of multiple cross-modulation images (a characteristic of all highly-sensitive FM receivers), switch to the "Local" position. In the "Local" position, the sensitivity of the Model S-3000 is reduced to 1/10 normal.

Should the local interference prevent reception of a desired distant station in a manner not alleviated by switching to "Local", write the Sherwood Electronic Lab. Service Dept. for information on an antenna filter trap tuned to the interfering station.

AUDIO LEVEL CONTROL—A level control is provided on the rear of the tuner chassis to regulate the audio output signal level fed to the amplifier.

SERVICING

REALIGNMENT—To check alignment, follow the chart below. Do not attempt realignment unless adequate test equipment is available. All coil cores have been sealed at the factory to prevent detuning during shipment; however, the sealing wax can be loosened when the proper alignment tool is used.

As suggested in step 8 optimum FM alignment, similar to the original factory alignment, consists of feeding a properly-terminated FM signal into the antenna terminals. To simulate a balanced 300-ohm input with the typical low-impedance single-ended generator, connect a 120-ohm carbon ½ watt resistor from each generator terminal to a tuner FM antenna input terminal. While observing the IF response curve with an oscilloscope connected through a 100K ohm resistor to the high side of R50, carefully adjust T1, T2, T3, T4 top and bottom for the maximum symmetrical response. Check the bandpass for 150KC flat top with 100% FM modulation. With this flat-top bandpass centered on the oscilloscope, repeat step 3 for a zero reading. This adjustment will ascertain that the AFC action will always pull the

tuning to the center of the pass band resulting in a minimum of distortion.

TUBE SUBSTITUTION—The 6BS8 cascode tube has been found to offer optimum sensitivity when used in the Model S-3000. However, either the 6BZ7, 6CH7, 6BQ7A or 6CX7 will operate, at reduced sensitivity when substituted.

FM DISTORTION—The Model S-3000 has been designed with the correct value of FM audio deemphasis feeding the audio system. Since this amount of deemphasis permits the overall FM audio response to be flat to 20,000 cps., any distortion generated at the FM station will be heard without moderation by the tuner. With a good high-fidelity speaker system, your ear will be acutely aware of any distortion generated in the system. If you suspect distortion in your FM reception, check several other FM stations to ascertain the degree of distortion originating in the program. Your Sherwood FM tuner has been checked to have less than 1% intermodulation distortion before leaving the factory. Each FM program probably has not had a similar check.

ALIGNMENT CHART

Generator Input: in every case, use the minimum generator input that will obtain a satisfactory output indication.

Alignment tools: IF and RF transformers require a plastic 0.102 in. hexagonal tool such as GC No. 8606.

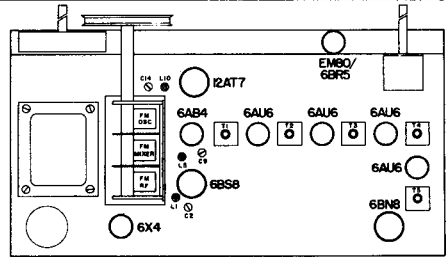

Tuner Switches	Signal Generator Input			Tuner dial setting	Indicating meter	Adjust	Indication	
	Coupling	Freq.	Modulation					
1	AFC off, Dist.	.01 uf to pin 6 6A84	10.7 mc	None	Point of no interference	Neg. DC VTVM on AGC (across C33)	T2, T1, top & bottom	Maximum deflection
2	"	"	"	"	"	Neg. DC VTVM through 100K ohms across C41	T3, top & bottom	" "
3	"	"	"	"	"	Neg. DC VTVM through 100K ohms to R50	T4, top or bottom	" "
4	"	"	"	"	"	Zero-center scale DC VTVM across C62	T5, bottom	Zero volts (between pos. & neg. reading)
5	"	300-ohm balanced input to FM ant. input	90 mc	400 cps. ±25kc FM	Check pointer for alignment at left hand start mark, then tune to 90mc	AC voltmeter or CRO at audio output	L10, L5, L1, T5 top	Maximum deflection
6	"	"	106mc	"	106mc	" "	C14, C9, C2	" "
7 Repeat steps 4 & 5 until no further improvement is possible.								
8	"	"	"	400 cps ± 250kc FM	"	CRO through 100K ohms to R50	T1, T2, T3, T4, top and bottom	Recheck for maximum deflection while adjusting for symmetry.

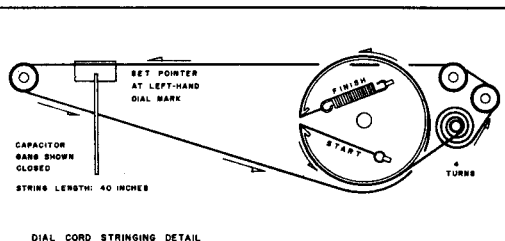
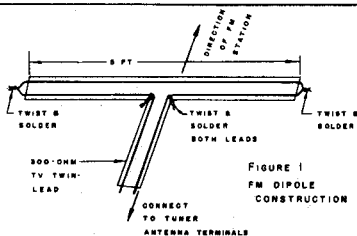

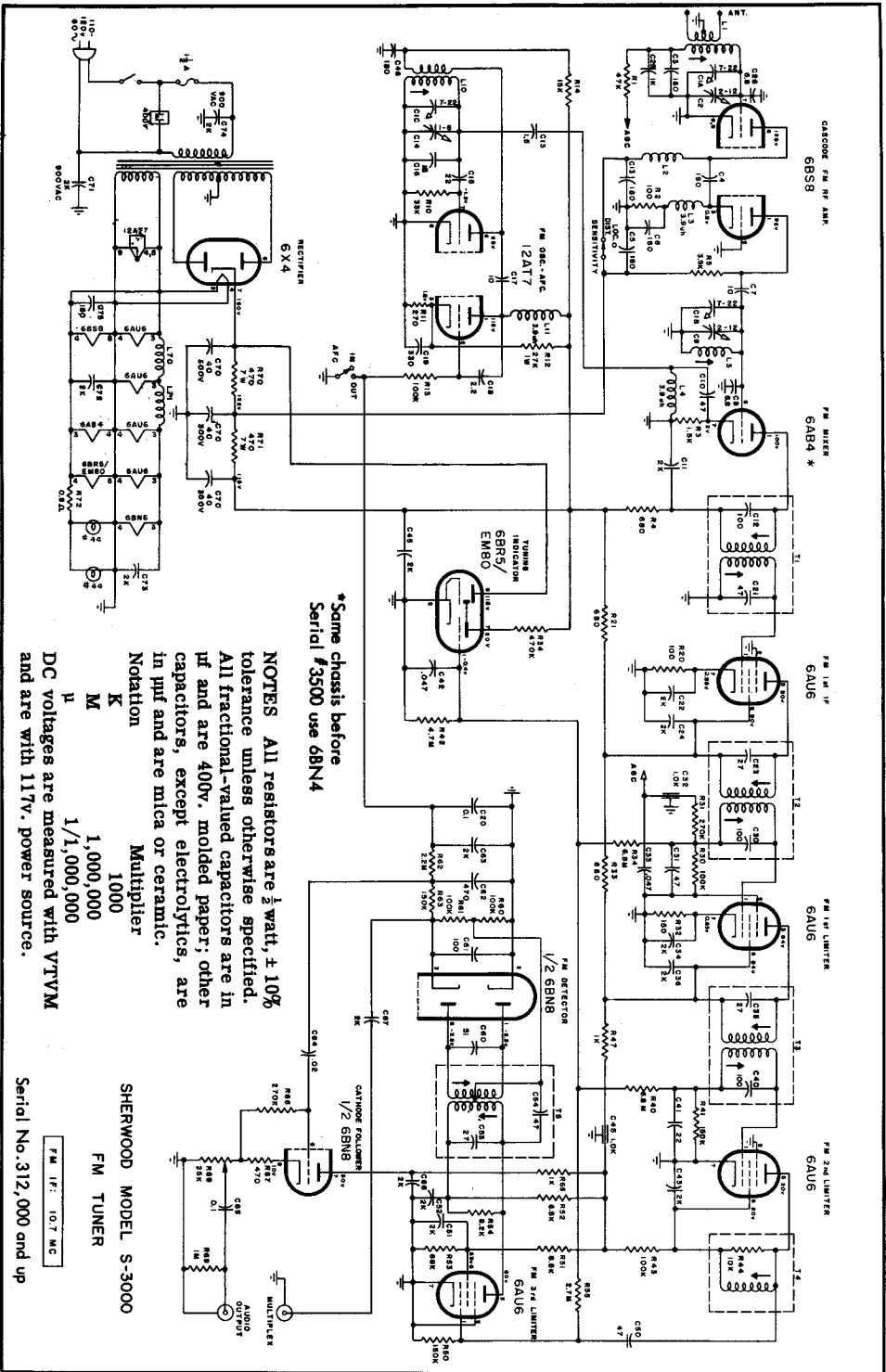

*Same chassis before Serial #3500 use 68N4

NOTES All resistors are $\frac{1}{2}$ watt, $\pm 10\%$ tolerance unless otherwise specified. All fractional-valued capacitors are in μ f and are 400v, molded paper; other capacitors, except electrolytics, are in puf and are mica or ceramic.

Notation

K	Multiplier	1,000,000
M		1,000,000
μ		1/1,000,000

DC voltages are measured with VTVM and are with 117v. power source.

SHERWOOD MODEL S-3000
FM TUNER

Serial No. 312,000 and up



ELECTRONIC LABORATORIES, INC.

4300 NORTH CALIFORNIA AVENUE, CHICAGO 18, ILLINOIS.