

Instruction Book

(RCG)

**MODEL AR-8505
RADIO RECEIVER**

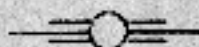

RADIO ENGINEERING OFFICE

RECEIVED

OCT 27 1943

A.M. P.M.
8 9 10 11 12 1 2 3 4 5 6

16

FEBRUARY-1942

ENGINEERING DEPARTMENT
RADIOMARINE CORPORATION OF AMERICA
75 VARICK STREET, NEW YORK, N.Y.

RADIO ENGINEERING OFFICE

FILE
COPY

AR-8505 RADIO RECEIVER

The Model AR-8505 radio receiver is a 7-tube super-heterodyne designed primarily for marine services for high-frequency reception. The receiver covers a continuous frequency range from 540 to 30,000 kilocycles. No plug-in coils are required since any frequency within the range specified may be quickly obtained by means of panel controls.

The receiver is mounted in a metal cabinet of the following dimensions: height 10 inches, width 17-3/4 inches, depth 12-1/4 inches. The weight is 33 pounds.

Four rubber shock mounts are provided at the base of the receiver for mounting the unit and to protect it from the effects of shipboard vibration.

The AR-8505 receiver has the following features:

1. Full-vision tuning dial calibrated directly in kilocycles.
2. Electrical band spread with separate tuning condensers.
3. Continuous frequency coverage with 4-position band switch.
4. Individual coil systems for each tuning range.
5. Separate audio and radio-frequency gain controls.
6. Panel switches for automatic volume control and CW oscillator control.
7. Operation from either A.C. or D.C. power supply.
8. Provision for doublet receiving antenna.

The following tube complement is used in the AR-8505 receiver:

RCA 6K8 mixer oscillator.
RCA 6L7 first intermediate amplifier.
RCA 6L7 second intermediate amplifier.
RCA 6SQ7 second detector, first audio and A.V.C.
RCA 25L6G second audio amplifier.
RCA 6J7 CW oscillator.
RCA 25Z5 rectifier.

Access to all tubes is obtained through a hinged cover on the cabinet.

The tuning ranges of the receiver are as follows:

- Range 1 - 11,200 to 30,000 kilocycles.
- Range 2 - 4,400 to 12,000 kilocycles.
- Range 3 - 1,500 to 4,600 kilocycles.
- Range 4 - 540 to 1,600 kilocycles.

The full-vision tuning scale is calibrated in kilocycles, and in addition is provided with a 0-100 scale for calibration or logging purposes.

The intermediate frequency of the receiver is 456 kilocycles. Three intermediate-frequency transformers are used, and are of the tuned iron core type.

The receiver is designed to operate directly from a 110-volt D.C. or A.C. power supply, and requires a line current of approximately .37 amperes or 40.7 watts. For operation from a 230-volt D.C. or A.C. line, an external resistor of 325 ohms (75 watts) is required, and this resistor should be ordered as an additional item for applications where the supply is 230 volts.

For headphone reception, high-resistance telephone receivers having a direct-current resistance of 2,000 to 3,000 ohms should be used. For loud-speaker reception, a standard 4-ohm voice coil type of permanent magnet loud-speaker is recommended. The output transformer from the second audio amplifier in the receiver is mounted in the chassis so that an additional matching loud speaker transformer is not required.

The AR-8505 receiver has the following panel controls:

1. Main tuning scale.
2. CW On-Off switch.
3. A.V.C. On-Off switch.
4. Audio-frequency gain control.
5. Radio-frequency gain control.
6. Main tuning control.
7. Band-spread tuning control.
8. Band switch.
9. Headphone jack.
10. Loud-speaker jack.

Binding posts for connection to a doublet antenna are mounted on the right side of the cabinet. A fuse block for

the incoming power line is located in the left rear corner of the chassis. Littlefuses No. 5 AG, 1-ampere rating, catalog No. 1160, code GOB, should be used.

The AR-8505 receiver is furnished with a spare tube for each socket, and 4 spare Littlefuses No. 5 AG, 1 ampere.

The sensitivity of the AR-8505 receiver is such that for CW reception a readable headphone signal may be obtained with an input at the antenna terminals of 1 to 2 microvolts. For reception of modulated waves, not using the CW oscillator, an input of 2 to 10 microvolts is required, depending on the frequency band in use.

The selectivity of the AR-8505 receiver is shown on the selectivity curve included in this book. Particular attention is directed to the high degree of selectivity that is available for adjacent channel interference so that interfering signals which are removed from the desired signal by 5, 10, or 15 kilocycles are highly attenuated. For example, in the marine high-frequency band if the receiver is tuned to 5545 kilocycles, an interfering signal in the next channel such as 5550 kilocycles is attenuated approximately 25 times. Likewise, if the receiver is tuned to 8450 kilocycles, an interfering signal in the adjacent channel of 8440 kilocycles is attenuated by a factor of approximately 500.

When the receiver is installed, it is recommended that the doublet antenna leadin which connects to the binding posts on the right side of the cabinet should be run in shielded twin-conductor wiring for locations where considerable external noise is prevalent. A standard marine-type doublet antenna is recommended; this antenna to have an overall length of approximately 60 feet, broken in the center with an insulator, and a suitable low-loss twisted pair leadin used to connect the center of the doublet to the AR-8505 receiver. The internal chassis of the receiver is insulated from the cabinet, and care should therefore be taken not to make any ground connections to the chassis. A ground connection may, however, be made to the external cabinet if it is found that in some installations such a connection will reduce local noise pickup. The small terminal board at the rear of the cabinet marked "BSW" is provided with a jumper connection which should be kept tight at all times. This terminal block is provided for special installations where it is found necessary to break the "B" supply to the receiver by means of an external switch or relay. The "B" supply circuit is also opened when the audio-frequency gain control is turned to the full counterclockwise position.

A complete connection diagram of the receiver is shown on Diagram T-738. The leadin from the doublet antenna passes through one section of the band switch to select the desired primary winding for the frequency band that is to be used. Other sections of the band switch select the appropriate grid coil for the mixer circuits of the 6K8 tube and also the appropriate plate and grid coils for the oscillator section of

the 6K8 tube. The plate circuit of the 6K8 connects to the primary of the first intermediate-frequency transformer, while the secondary of this transformer is connected to the grid circuit of the first 6L7 intermediate-frequency amplifier in the conventional manner. The second intermediate-frequency amplifier is connected as shown, and feeds into the various circuits of the 6SQ7 tube. The 6SQ7 functions as a second detector, automatic volume control, and also as the first stage of audio amplification. The audio output of this tube is coupled to the control grid of the 25L6G second audio amplifier. The primary winding of the 25L6G output transformer is connected through blocking condensers to the headphone jack, while the secondary winding connects to the loud-speaker jack. The loud-speaker jack is arranged so that when the loud-speaker is disconnected, a 4-ohm resistor is placed across the secondary winding to maintain a correct load on the output tube. The 6J7 CW oscillator tube is arranged to operate at a frequency approximately one kilocycle above or below the intermediate frequency of 456 kilocycles. The output of the 6J7 tube is coupled to one of the diodes of the second detector through a 2-mmfd. condenser. All heaters of the tubes are wired in series and are connected through a 95-ohm resistor to permit operation directly from a 110-volt source. The 25Z5 rectifier tube functions in the conventional manner for A.C. supply, and in the case of D.C. supply is used to prevent damage to the electrolytic condensers in the filter network in the event that incorrect polarity is accidentally applied to the power input terminals of the receiver.

The following operating procedure is recommended for best results. The band-spread tuning control should normally be left at 90 on the lower scale below the engraving on the dial mark "SET." The main tuning control is calibrated on the basis that the band-spread control is adjusted to 90 or "SET." After a signal is tuned in, the band-spread control may then be used for accurate adjustments. For receiving very weak signals, which do not fade appreciably, the best signal-to-noise ratio will be obtained by leaving the automatic volume control switch "Off," by adjusting the A.F. gain control to a fairly high value, and then by adjusting the R.F. gain control to the desired signal level. In the case of fading signals when A.V.C. is required, maximum A.V.C. action will be obtained by adjusting the R.F. gain control to a high value and then regulating the signal volume by means of the A.F. gain control. When receiving under conditions of strong interference from other stations, it will be found helpful not to use A.V.C. in order to avoid suppression of the desired signal by the interfering signal, which would otherwise actuate A.V.C. circuits and thus reduce or wipe out the desired signal.

It is not recommended that any attempts should be made to line up the receiver aboard ship by adjusting the I.F. transformers or any of the trimmer condensers on the underside of the chassis. Accurate laboratory equipment is required

for correct lineup, and any attempts that are made to adjust the various trimmers without suitable test equipment will invariably result in more harm than good, and will impair the calibration, sensitivity and selectivity of the receiver. If the performance of the receiver becomes subnormal and cannot be restored by replacing tubes, it is recommended that the receiver be returned to the Radiomarine Corporation for repairs. Filament failure of any tube will result in all tubes running "cold" since the heaters are wired in series. The defective tube should be located by replacing all tubes one at a time, taking care always to replace the correct type of tube in its respective socket. The two tubes which use 25 volt heaters are the two glass tubes near the fuse block. All metal tubes are of the 6.3 volt heater type. Top cover of cabinet should be kept tight with the two hold-down screws at all times to avoid variations in beat note for CW reception.

Access to the underside of the chassis is obtained by removing the bottom tray from the cabinet. This is done by removing the three large screws in a row at the bottom of the front panel, three other screws on each lower side of the cabinet, and three screws in the lower rear of the cabinet. Do not remove any other screws than those specified above. Continuity of coils may be checked by means of resistance measurements by referring to the values shown on Diagram T-738. Likewise, all resistors may be checked and condensers tested for shorts with a standard volt ohmmeter. The various socket voltages shown on Drawing K-52 are measured with a high-resistance voltmeter using a voltmeter scale nearest to the values of the voltage under measurement.

NOTE #1 - Radiomarine Corporation reserves the right to change specifications and designs of equipment described in this book.

NOTE #2 - The various component units referred to in this instruction book, or on circuit diagrams, are not to be construed as a "bill of material". Material furnished for a particular order will be in accordance with the specifications or requirements of that order.

ENCLOSURES: Photograph (Frontispiece)
Drawing T-738 - Circuit Diagram
Drawing K-51
Drawing K-52

10,000

1,000

100

10

1

TIMES NORMAL INPUT

AR-8506 RECEIVER
OVERALL I.F. SELECTIVITY
456 K.C., I.F.

RADIOMARINE CORP. OF AMERICA
Engineering Dept.
Dwg. K-51, October 30, 1939

-15 KC -10 KC -5 KC 0 +5 KC +10 KC +15 KC

K.C. OFF RESONANCE

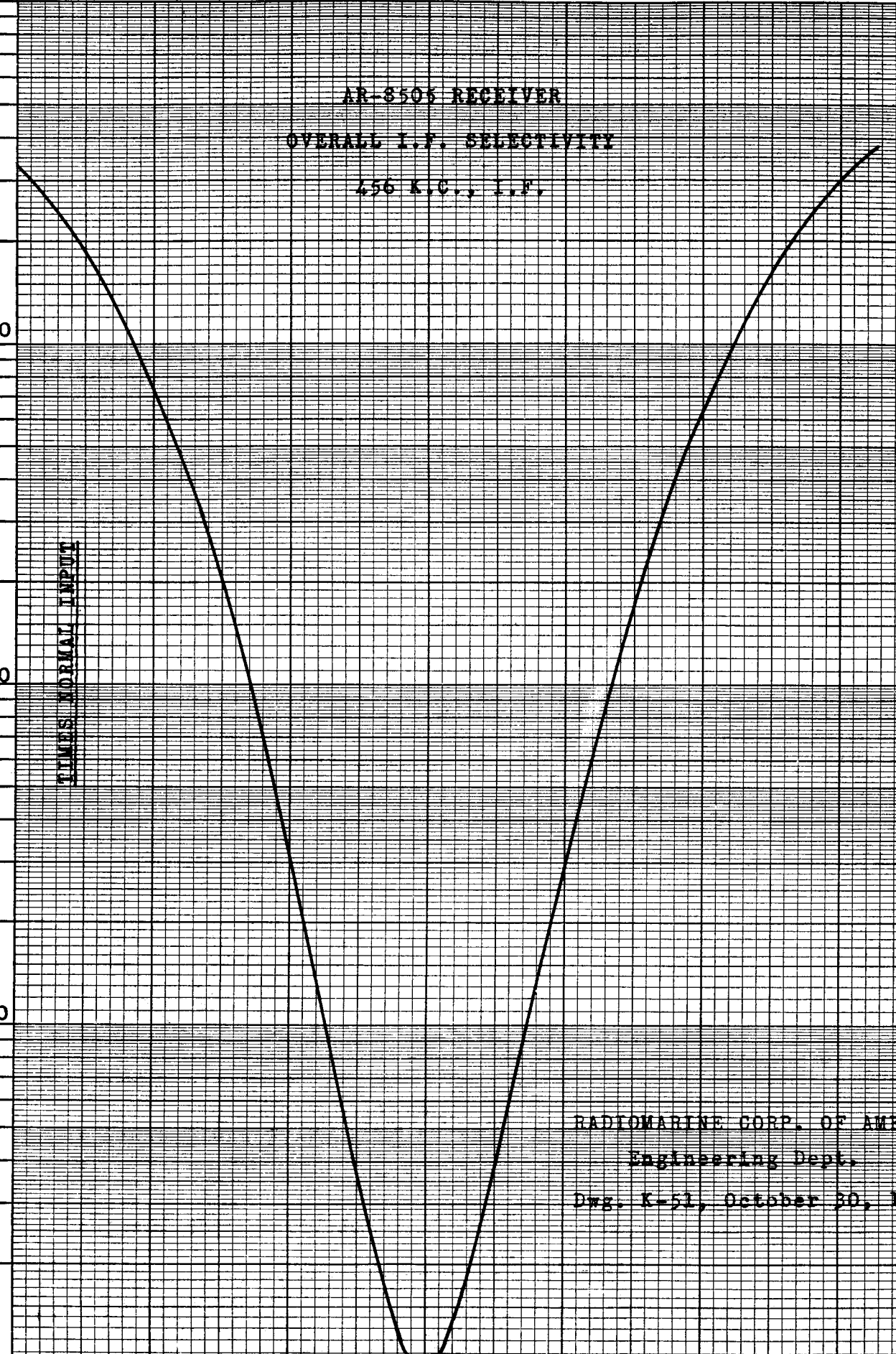

Doublet Ant.

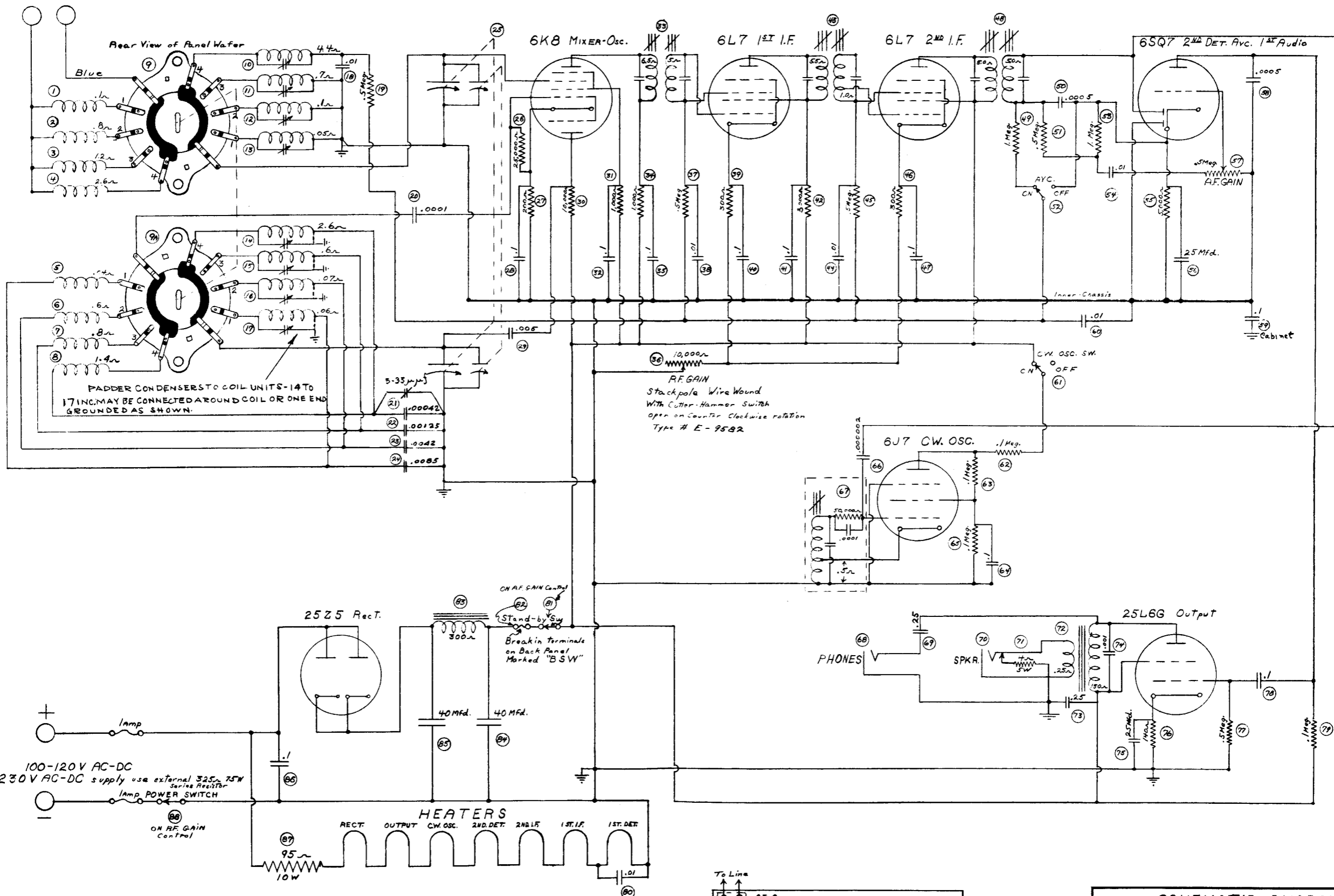

100-120V AC-DC
For 230V AC-DC supply use external 325Ω 75W series resistor

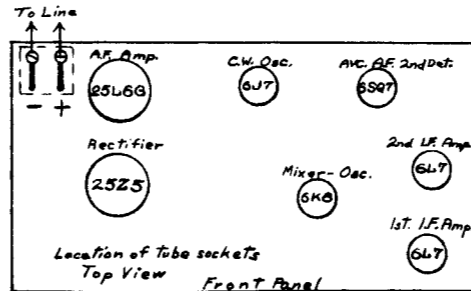
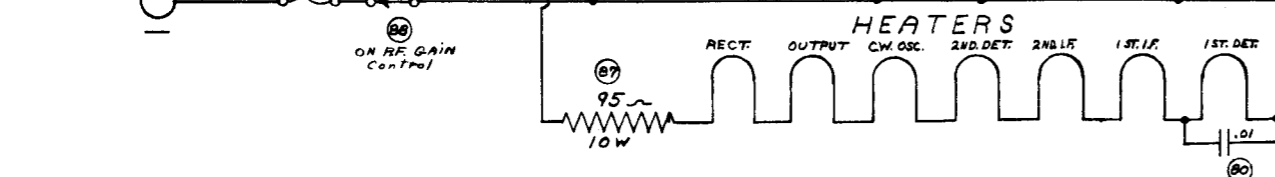

SCHEMATIC DIAGRAM
AR-850.5 SHORT WAVE RECEIVER

RADIOMARINE CORP. OF AMERICA

ENGINEERING DEPT.	Drawn by <i>J.G.H.</i>
NEW YORK	Checked by <i>XZ</i>
T-738	
Date Mar. 2, 1939	

Last Item No. 63

Sub. 2 - 2/11/42 Padder Conn's S.S.
Sub. 1 - 10/1/41 Padder Values G.C.H.

AR-8505 SOCKET VOLTAGES

All measurements made with 110-volt D.C. line using 1000 ohms per volt meter. All voltages measured to inner chassis.

6K8 Mixer-Oscillator

#1	0.0 V.	#5	-----
#2	6.3 V.	#6	65.0 V.
#3	81.0 V.	#7	0.0 V.
#4	82.0 V.	#8	1.5 V.

6L7 1st I.F.

#1	0.0 V.	#5	0.0 V.
#2	12.3 V.	#6	0.0 V.
#3	77.0 V.	#7	6.3 V.
#4	77.0 V.	#8	2.2 V.

6L7 2nd I.F.

#1	0.0 V.	#5	0.0 V.
#2	12.3 V.	#6	0.0 V.
#3	84.0 V.	#7	18.6 V.
#4	84.0 V.	#8	2.75 V.

6SQ7 2nd Det., 1st Audio & A.V.C.

#1	0.0 V.	#5	0.0 V.
#2	0.0 V.	#6	55.0 V.***
#3	0.5 V.	#7	25.0 V.
#4	0.0 V.	#8	18.5 V.

6J7 CW Oscillator

#1	0.0 V.	#5	0.0 V.
#2	25.0 V.	#6	83.0 V.
#3	28.0 V.***	#7	32.0 V.
#4	10.0 V.***	#8	0.0 V.

25L6G Output Tube

#1	0.0 V.	#5	0.0 V.
#2	55.0 V.	#6	0.0 V.
#3	78.0 V.	#7	31.0 V.
#4	83.0 V.	#8	5.3 V.

25Z5 Rectifier

#1	80.0 V.	#4	102.0 V.
#2	108.0 V.	#5	108.0 V.
#3	102.0 V.	#6	55.0 V.

Bottom View of 25Z5 Rectifier Socket

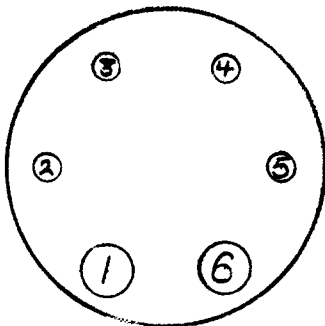

Bottom View of Octal Tube Sockets

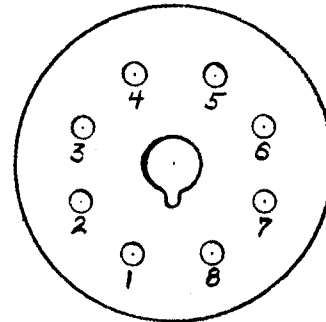

SOCKET VOLTAGES FOR
MODEL AR-8505 SHORT WAVE RADIO RECEIVER

RADIOMARINE CORPORATION OF AMERICA

*** Measured on 300-volt range.

Engineering Dept.

Measurements
by F.E.S.

New York

Sub 0

K-52

10/31/39